



EC type Examination Certificate

0402-MID-SC0583-10

Issued to

Finn Frogne A/S, Ishøj Søndergade 19, DK-2635 Ishøj, Danmark

In respect of (type of instrument)

Taximeter Frogne TM3

In accordance with

The Measuring Instruments Regulations STAFS 2016:1 and The Regulations and Guidelines concerning Taximeters STAFS 2016:8 dated 2016-03-29, implementing in the NB's country law the Directive 2014/32/EU of 26 February 2014 on measuring instruments (MID).

Applicable essential requirements of directive 2014/32/EU

- Annex I, Essential requirements
- Annex IX (MI-007), Taximeters

Harmonised standards and normative documents used

OIML R21 Taximeters Metrological and technical requirements, test procedures and test report format (applied partly)

Further applied documents

WELMEC 7.2, Software Guide (Issue 4)

OIML D 11 Edition 2004 (E), General requirements for electronic measuring instruments

PTB-A 18.21 Messgeräte im Straßenverkehr - Quittungsdrucker für Taxameter

Information regarding applied environmental testing is evident from clause 9 of the appendix.

Rated operating conditions

Measurand:	Time and or distance	Mechanic environment class:	M3
Measurement range:	Maximum 6 digits on the display (corresponding to the fare to be paid)	Electromagnetic environment class:	E3
Accuracy:	- Time elapsed: $\pm 0,1$ % - Distance travelled: $\pm 0,2$ % - Calculation of the fare: $\pm 0,1$ % - Measuring range: 500-100000 pulses/km	Climatic environment:	-25 to +70 °C Condensing Closed (installed in a car)

Miscellaneous

Valid until April 7, 2021. This certificate is the seventh edition with this number and replaces the earlier edition dated July 8, 2015.

The principal characteristics, approval conditions are set out in the appendix hereto. All the plans, schematic diagrams and documentations are recorded under reference files ELe PX01883, PX22406, 3P04682, 3P0835, 5P01622 and 7P01206.

SP Technical Research Institute of Sweden Certification - Notified Body No. 0402

Lennart Aronsson
Product Certification Manager

Anders Nilsson
Certification Officer



Certificate issue 7, dated 2017-04-28

SP Technical Research Institute of Sweden

Box 857, SE-501 15 Borås, Sweden
Phone: +46 10-516 50 00
E-mail: info@sp.se / www.sp.se

Swedish Notified Bodies are appointed by SWEDAC, the Swedish Board for Accreditation and Conformity Assessment, under the terms of Swedish legislation. This certificate may not be reproduced other than in full, except with the prior written approval by SP. SP's Certification Rule SPCR 302 has been applied. The certificate, including appendices consists of 11 pages where this is page 1.

The instruments / measuring systems must correspond with the following specifications:

1 Design of the instrument

1.1 Construction

Product names

TM3 consists of:

TM3/3000 (Central processor unit)

TM3/3100 (Display)

A printer can be connected to the system, but is not a requirement according to directive 2014/32/EU.

Measuring system description

The taximeter is designed to measure time and receive information to calculate distance. Time is measured by its internal real time clock and distance is calculated by the number of pulses received from the pulse generator of the car in relation to the given pulse constant. The supply voltage is taken from the battery of the vehicle. For connections see the schematic picture below.

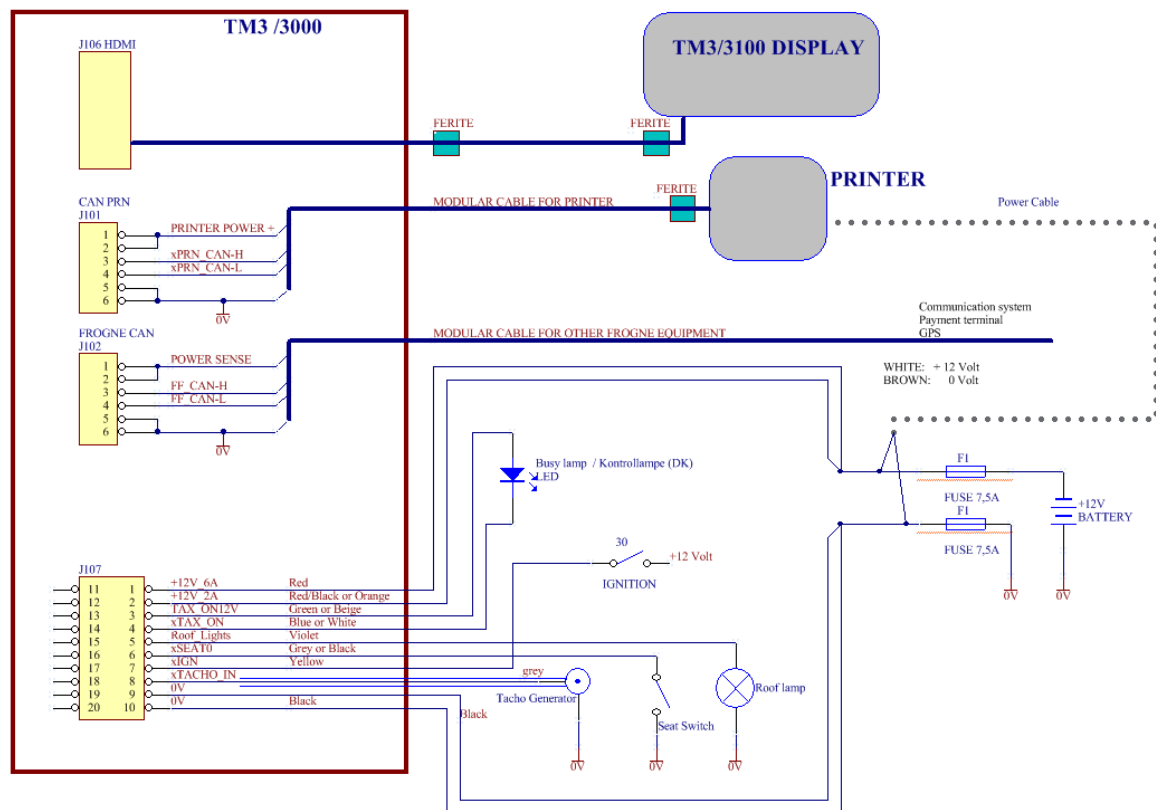

Figure 1: Taximeter connections

Certificate issue 7, dated 2017-04-28

SP Technical Research Institute of Sweden

Box 857, SE-501 15 Borås, Sweden
 Phone: +46 10-516 50 00
 E-mail: info@sp.se / www.sp.se

Swedish Notified Bodies are appointed by SWEDAC, the Swedish Board for Accreditation and Conformity Assessment, under the terms of Swedish legislation. This certificate may not be reproduced other than in full, except with the prior written approval by SP. SPs Certification Rule SPCR 302 has been applied. The certificate, including appendices consists of 11 pages where this is page 2.

EU-type Examination Certificate

Appendix



Figure 2: Central Processor Unit (CPU) TM3/3000



Figure 3: Display TM3/3100

Supply voltage

Taximeter (CPU): 9-16 V

Connection to pulse generator of the vehicle

The pulse from the pulse generator of the car is to fulfil the following the requirements according to the manufacturer:

The distance signal generator should produce

Signal type: Square or sine wave

Maximum frequency: 5.000Hz

Constant of distance signal generator: 500-100000 pulses/km

Signal amplitude: 2.1-24 Vpp

Minimum high time and minimum low time 72 μ sec

Signal output type: Push-pull or open collector with pull-up resistor

Load impedance: minimum 100 kOhm || maximum 2 nF

1.2 Software

The validation of software was based on the essential requirements given in MID and WELMEC Guide 7.2.

Software version

The following program versions are approved:

Type of program	Program version	Checksum
Taximeter program	1.0.807	0x31E5
Taximeter program	1.1.1006	0xF54D
Taximeter program	1.2.1071	0x8DC2
Taximeter program	1.3.1098	0xDAA5
Taximeter program	1.4.1213	0x5CDB
Taximeter program	1.5.1343	0x20A3



EU-type Examination Certificate

Appendix

The taximeter versions can be seen by pressing “Funktioner” (Functions), “System” (system), “Versioner” (versions) and software. If the taximeter is in the mode “Avstängd” (Closed) the versions can be seen by pressing arrow forward and then continue from “System” above. The taximeter has three levels of software identification where MID SW version and “checksumma” (checksum) are including the parts specified in the directive, NM SW version and “checksumma” are including national requirements and FF version and “checksumma” are including functions not specified in neither the directive nor national regulations.

Alternatively if a printer is connected the number and the checksum can be read by making a “Taxameterkontroll”* (“Kontroll” (check) and “T-kontroll” or if the taximeter is in the mode “Avstängd” (Off) the check is reached by arrow forward and then “Kontroll” in accordance with above.

- * The mode “Taxameterkontroll” is a print-out intended for the police or other authority in order to check e.g. the totalisers, the date of securing and the tariff values.

If a minimum price is applied the minimum price must be evident for the customer at the start of the hire.

No function of discount has been verified to fulfil the requirements.

No function of tariff change based on price has been verified to fulfil the requirements.

1.3 Components included for electronic function

According to documentation “Annex to Application for conformity assessment of Taximeter in accordance to MID” dated 05-04-11.

1.4 Optional equipment and functions subject to MID requirements

None identified

1.5 Technical documentation

For market surveillance the construction, software and included components are described in 1.1, 1.2 and 1.3.

1.6 Integrated equipment and functions not subject to MID

Software to fulfil national requirements or to communicate with booking central etc. must not influence the accuracy of measurements such that the maximum permissible error is exceeded or the required functions are changed.

Certificate issue 7, dated 2017-04-28

SP Technical Research Institute of Sweden

Box 857, SE-501 15 Borås, Sweden
Phone: +46 10-516 50 00
E-mail: info@sp.se / www.sp.se

Swedish Notified Bodies are appointed by SWEDAC, the Swedish Board for Accreditation and Conformity Assessment, under the terms of Swedish legislation. This certificate may not be reproduced other than in full, except with the prior written approval by SP. SPs Certification Rule SPCR 302 has been applied. The certificate, including appendices consists of 11 pages where this is page 4.



EU-type Examination Certificate

Appendix

2 Technical data

2.1 Rated operating conditions

Measurand

Time and or distance.

Measurement range

Maximum levels for the taximeter:

Total distance: 42949672.00 km

Total distance in taxi traffic (driver logged in): 42949672.00 km

Total amount: 42949672 monetary units

Total amount supplements: 42949672 monetary units

The limitation is the maximum fare that can be displayed. The amount is limited to 6 digits e.g. 999999 SEK.

Accuracy

- Time elapsed: $\pm 0,1 \%$
- Distance travelled: $\pm 0,2 \%$
- Calculation of the fare: $\pm 0,1 \%$
- Pulse range: 500-100000 pulses/km

Environments classes / influence quantities

Mechanic:	class M3
Electromagnetic:	class E3
Ambient temperature limits:	-25°C to +70°C
Humidity:	condensing
Location:	closed (inside a car)

2.2 Other operating conditions

Not applicable.

3 Interfaces and compatibility conditions

See clause 1.1



EU-type Examination Certificate

Appendix

4 Requirements on production, putting into use and utilisation

The requirements of the installation manual are to be followed when installed in a car and put into use.

4.1 Requirements on production

No special requirements identified.

4.2 Requirements on putting into use

The taximeter must be adapted to the vehicle.

4.3 Requirements for consistent utilisations

No special requirements identified.

5 Control of the measuring tasks of the instrument in use

5.1 Documentation of the procedure

The procedure to control the accuracy after installation in a car is described in the user's manual.

5.2 Special equipment or software, if applicable

A stop watch or other time measure equipment is needed.

5.3 Calibration-/adjustment procedure

The taximeter can be controlled after installation in a car in the following way.

Accuracy of distance measurement

To check the accuracy of distance measurement the following procedure is to be followed:

Start the RTC by "Funktioner" (Functions), Test and "RTC-Klocka". Press "Nullstill test" (clear test) at the same time as a calibrated stop watch is started. Carry out the test during at least 30 min.

Accuracy of time measurement

To check the accuracy of time measurement the following procedure is to be followed:

Carry out testing at an even distance of 1000 meter at equal speed and with flying start. Start Tk test by the use of "Funktioner" (Functions), Tk test. When the distance starts press "Starta" (start) and when the distance ends press "Stopp" (stop). The result can be read from the display or print-out.

EU-type Examination Certificate

Appendix

6 Security measures

6.1 Sealing

The taximeter is sealed according to page 7 and 8.

The CPU is to be fixed to the vehicles with three or four screws. Two of the screws are to be placed under the lid where the cables are connected (service area), marked with a blue rectangle in figure 4. The screw for the lid is then sealed (see figure 5), which means that in order to remove the taximeter the seal has to be broken and hence leaving tracks.



Figure 4: How to fasten the CPU

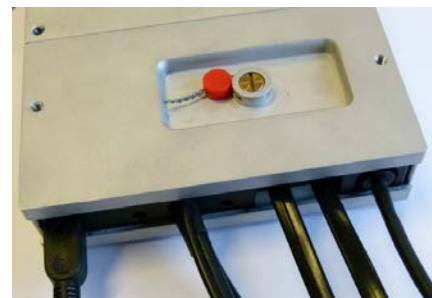

Figure 5: Sealing of lid to service area of CPU

Cables for supply voltage and pulses are sealed by using a sealing plate (see figure 6) that is placed under the sealed lid for the service area.

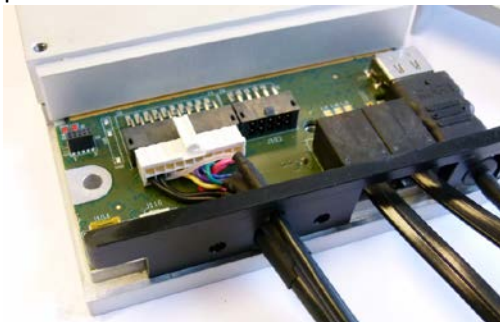

Figure 6: Sealing plate

On the backside of the CPU the screws are sealed with the warranty marking in accordance with figure 7 and 8 below.



Figure 7 and 8: Factory sealing of the CPU unit and label for the factory sealing

Certificate issue 7, dated 2017-04-28

SP Technical Research Institute of Sweden

Box 857, SE-501 15 Borås, Sweden
 Phone: +46 10-516 50 00
 E-mail: info@sp.se / www.sp.se

Swedish Notified Bodies are appointed by SWEDAC, the Swedish Board for Accreditation and Conformity Assessment, under the terms of Swedish legislation. This certificate may not be reproduced other than in full, except with the prior written approval by SP. SPs Certification Rule SPCR 302 has been applied. The certificate, including appendices consists of 11 pages where this is page 7.

EU-type Examination Certificate

Appendix

6.2 Data logger

The totalisers are stored in FRAM (non-volatile) memory.

The taximeter has two event logs, Auditlog and Lifelog, which both are reach if pressing “Funktioner” (Functions), “Log”, the chosen log and “Visa log” (show log). In Auditlog opening of electronic seal, change of k-value, change of program version and tariff changes can be seen. In lifelog setting of serial number and language version can be seen.

7 Labelling and inscriptions

7.1 Information to be borne by the instrument

The marking on the instrument shall contain the following information:

- the name of the manufacturer
- the serial number
- the designation or type name (according to “Product names” Appendix page 1)
- the EC-type examination certificate number, 0402-MID-SC05083-10
- the accuracy class
- markings regarding other approvals
- marking regarding additional devices not being covered by MID



Figure 9: Placement of marking on the CPU. XX XX-yy is to be replaced by the approval number. 11 is to be replaced by the year of manufacturing.

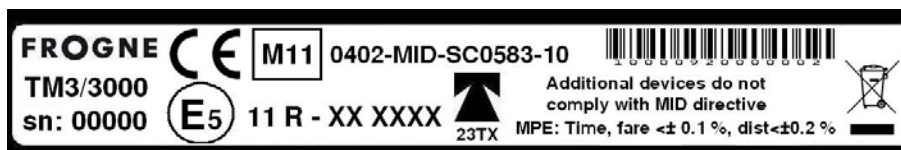

Figure 10: Layout of marking on the CPU



Figure 11: Alternative layout of marking on the CPU

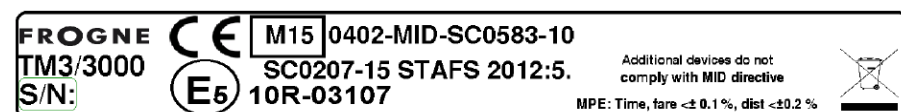

Figure 12: Alternative layout of marking on the CPU

Certificate issue 7, dated 2017-04-28

SP Technical Research Institute of Sweden

Box 857, SE-501 15 Borås, Sweden
 Phone: +46 10-516 50 00
 E-mail: info@sp.se / www.sp.se

Swedish Notified Bodies are appointed by SWEDAC, the Swedish Board for Accreditation and Conformity Assessment, under the terms of Swedish legislation. This certificate may not be reproduced other than in full, except with the prior written approval by SP. SPs Certification Rule SPCR 302 has been applied. The certificate, including appendices consists of 11 pages where this is page 8.

EU-type Examination Certificate

Appendix

Marking of the display is to be placed on the rear side.

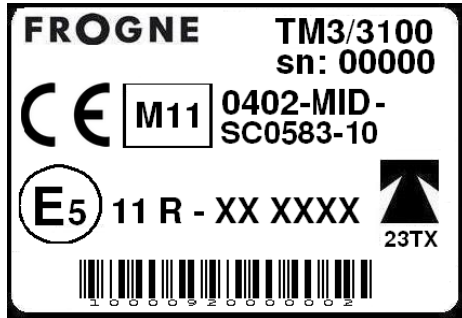

Figure 13: Marking on the display. 11 is to be replaced by the year of manufacturing.

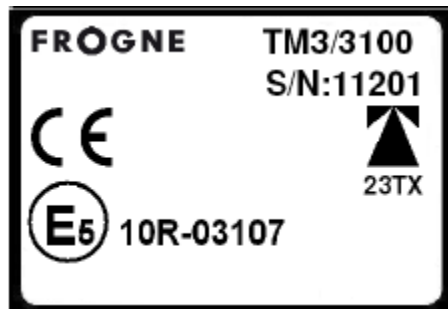

Figure 14: Alternative marking on the display.

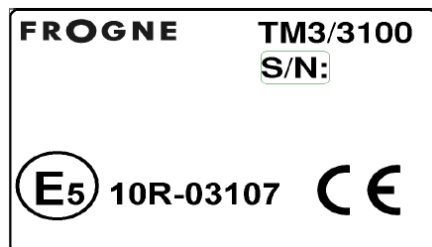

Figure 15: Alternative marking on the display.

7.2 Conformity marking in accordance to MID article 17

The instrument shall be marked in accordance to MID article 17 which e.g. describes the CE-marking together with M, year of marking and the notified body number.

7.3 Further inscriptions, if necessary

Further inscriptions e.g. e- or E-marking and national markings are necessary, but are not connected to this directive.

EU-type Examination Certificate

Appendix

8 Manuals

The following manuals are to accompany the different systems in the official language of the country of use (the manufacturer is responsible for the translation of approved documents).

<i>Program version</i>	<i>Title of manual</i>	<i>Document version</i>	<i>Language of examined version</i>
1.0.807	Vejledning til FROGNE TM3 Taxametersystem	0.27	Danish
1.1.1006	Vejledning til FROGNE TM3 Taxametersystem	0.29	Danish
1.3.1098	Handbuch FROGNE TM3 Taxameter	0.33	German
1.4.1213	Manual til FROGNE TM3 Taxametersystem	0.34	Danish
1.5.1343	Vägledning till FROGNE TM3 Taxametersystem	0.35	Swedish

For installation purposes the installation manual “Frogne TM3 Installation Guide”, version 1.0.7 (examined in English version) is to be followed.

9 Applied environmental testing

Vibration

IEC 60068-2-64 revision 1, test Fh (this is a higher severity than Class M3 in accordance with OIML D11):

10-20 Hz: 0.05 g²/Hz

20-500Hz: -3 dB/octave

Testing was carried out in three mutually perpendicular axes for 0.5 hours in each direction and the taximeter was connected to power during testing.

Dry Heat

OIML D11 with testing according at IEC 60068-2-2 test Bd, but with the duration 16h and the highest temperature +70°C.

The test object was connected to power during the test.



EU-type Examination Certificate

Appendix

Cyclic damp heat/Cold

Testing of cold and damp heat was carried out in accordance with the climate sequence of IEC 60068-2-61.

First one cycle damp heat was carried out according to IEC 60068-2-30 edition 2 revision 1. test Db. temperature: +55 °C. The taximeter was not connected to power during testing.

After recovery in controlled atmosphere during 1 h ±5 min cold test according to IEC 60068-2-2 edition 5 revision 2 test Ab at -40 °C during 16 h was carried out. Functional testing was carried out at -25°C.

After finalisation of the cold test 5 cycles of damp heat was carried out according to IEC 60068-2-30. edition 2. revision 1. test Db. +55 °C. The taximeter was not powered during testing.

Emission

EN 55022:2006, /A1:2007 class B

Immunity

OIML D11 12.2 Electrostatic discharged according to IEC61000-4-2, level 3

OIML D11 12.1.1/1 and 12.1.1/2 Radiated RF immunity according to IEC61000-4-3, 24 V/m

OIML D11 12.1.2 Injected RF immunity according to IEC61000-4-6, 20 V

OIML D11 14.2.2 Automotive voltage transient immunity according to ISO 7637-2, level 4, pulses 1, 2a, 2b, 3a, 3b, 4 and 5

OIML D11 14.2.3 Automotive voltage transient immunity ISO 7637-3, level 4, pulses 3a and 3b

PTB-A 18. (2005) Immunity to fast transients according to EN 61000-4-4

Certificate issue 7, dated 2017-04-28

SP Technical Research Institute of Sweden

Box 857, SE-501 15 Borås, Sweden
Phone: +46 10-516 50 00
E-mail: info@sp.se / www.sp.se

Swedish Notified Bodies are appointed by SWEDAC, the Swedish Board for Accreditation and Conformity Assessment, under the terms of Swedish legislation. This certificate may not be reproduced other than in full, except with the prior written approval by SP. SPs Certification Rule SPCR 302 has been applied. The certificate, including appendices consists of 11 pages where this is page 11.